

SPACE SHUTTLE ORBITER NOSE CAP AND WING LEADING EDGE
CERTIFICATION TEST PROGRAM

Murray J. Suppanz*
John E. Grimaud**

ABSTRACT

A reinforced carbon-carbon thermal protection system is used on the Space Shuttle orbiter vehicle's nose cap and wing leading edge regions where temperatures reach 1538°C (2800°F). To verify the analyses used to certify reinforced carbon-carbon for the first flight and operational missions, a unique multi-environment incremental test program was developed and implemented through the combined efforts of Rockwell International and the National Aeronautics and Space Administration. Three separate facilities at the Johnson Space Center were used to subject full-scale nose cap and wing leading edge test articles to simulated critical launch, on-orbit, and atmospheric entry environments.

INTRODUCTION

During atmospheric entry, the Space Shuttle orbiter vehicle's external surfaces will reach temperatures up to 1538°C (2800°F) in regions of highest aerodynamic heating. Unlike the Apollo spacecraft, which was designed for a single-mission life and employed a nonreusable charring ablator thermal protection system (TPS) to protect the structure from aerodynamic heating during entry, the orbiter was designed to be reusable for up to 100 missions with minimal refurbishment between flights. Therefore, the orbiter TPS must be able to withstand fatigue loading.

The orbiter TPS consists of four different material configurations (Figure 1), each optimized for a specific maximum temperature range of operation. The vehicle surfaces that will encounter the highest temperatures are protected by reinforced carbon-carbon (RCC), which can withstand thermal and structural loads generated by the flight environment of the orbiter. The remainder of the vehicle's surface is covered with various forms of reusable surface insulation (RSI). The RCC components (including their internal insulation, supporting structure, support links, and attachment fittings), and the tiles and seals at the interface of the RCC and RSI make up the orbiter's leading edge structural subsystem (LESS). The LESS components, consisting of the nose cap and wing leading edges, were designed on the basis of thermal and structural analysis

*Space Systems Group, Rockwell International, Downey, California

**Lyndon B. Johnson Space Center, National Aeronautics and Space Administration, Houston, Texas

programs that predicted the reaction of these components to theoretical flight environments. However, because of the complexity of the LESS design, the types of materials involved, and the range of environmental conditions the LESS must withstand, extensive testing was required to verify these analyses.

The required testing involved a unique test program and facilities that could simulate the critical environments of launch, earth orbit, and entry into the earth's atmosphere. Through the combined efforts of Rockwell International and the National Aeronautics and Space Administration (NASA), a comprehensive test program was developed in three facilities at the Johnson Space Center (JSC), where the nose cap (NC) and wing leading edge (WLE) test articles were sequentially exposed to simulated critical portions of flight.

These test articles (Figure 2)—designed to duplicate the thermal, dynamic, and structural qualities of the orbiter—were manufactured according to production procedures. The NC test article consisted of RCC components, structural attachments, internal high-temperature thermal insulation blankets, a portion of the forward fuselage interface containing HRSI TPS tiles, thermal barriers, and related thermal control system (TCS) multilayer insulation blankets. The WLE test article consisted of a 7-foot section of the wing box and front spar, two RCC panels with a T-seal interface and structural attachments, high-temperature spar insulation blankets, interface and wing HRSI and LRSI TPS tiles, and related thermal barriers. These articles, with their hundreds of instrumentation sensors, were exposed sequentially to acoustic excitation, structural airloads, on-orbit cold soak, and atmospheric entry thermal conditions to simulate the critical flight environments of a typical mission.

The goal of this test program was to support certification of the LESS for 100 missions by experimental verification of the design analyses. This paper provides an overview of the orbiter TPS and describes in detail the LESS NC and WLE test articles, test program philosophy, test environments, facility considerations, and results of completed tests that support certification of the orbiter LESS for the first orbital flight.

TPS REQUIREMENTS

The TPS associated with the Space Shuttle orbiter vehicle must attenuate aerothermal heating, which results in temperatures up to 1538°C (2800°F) on the vehicle's external surfaces, to protect the aluminum structure from exceeding its design limit temperature of 176°C (350°F) during any phase of the Shuttle mission. The TPS must also sustain acoustic and structural loads and deflections, as well as natural environments such as salt spray, fog, and rain. In addition, the system must provide an acceptably smooth aerodynamic surface, be reusable with minimal refurbishment over a 100-mission life, and be weight efficient without imposing unrealistic manufacturing, installation, or flight constraints. The TPS must also perform efficiently as an element of the thermal control system, whose purpose is to keep the temperature of the structure and vehicle subsystems within limits during earth orbit.

TPS DESIGN

The TPS consists of both active and passive elements. Active elements include movable seals and flow barriers associated with the aerodynamic control surfaces (i.e., elevons, rudder, and body flap). Passive elements comprise the different TPS materials covering the entire external surface of the vehicle.

The passive TPS consists of four different material configurations (Figure 1), each optimized for a specific operational temperature range. One, fabricated RCC, is used in the areas of highest heating on the vehicle—the NC and the WLE—where temperatures generally exceed 1260°C (2300°F). The material construction is a multilayer graphite laminate with an oxidation-resistant coating, molded to the desired shape, and mechanically attached by Inconel fittings to a forward bulkhead or wing spar. The RCC is also designed to withstand aerodynamic loads and serves as an extension of the aluminum primary structure. Because RCC is not a good insulator, the adjacent aluminum structure and Inconel attachment fittings must be protected from exceeding design temperature limits by internal insulation.

The remaining three material configurations are broadly characterized as reusable surface insulation. Only two are used on the WLE and NC test articles, but a description of each follows to provide an overview of the entire orbiter TPS.

High-temperature reusable surface insulation (HRSI) tiles are used in areas where temperatures are generally below 1260°C (2300°F) and above 648°C (1200°F). These tiles are nominally squares 15.24 by 15.24 centimeters (6 by 6 inches) made from low-density, high-purity silica fibers. The top and sides are covered with a tetrasilicide-borosilicate glass coating that provides a surface emittance of 0.85 and a solar absorptance of 0.85. In addition, the tiles are waterproofed with a silicone resin. HRSI tiles weigh either 144 or 352 kilograms per cubic meter (9 to 22 pounds per cubic foot) depending on the area of application, and they vary in thickness from 2.54 to 12 centimeters (1 to 5 inches). Approximately 20,000 HRSI tiles are used on the orbiter vehicle.

Low-temperature reusable surface insulation (LRSI) tiles are used in areas where temperatures are generally below 648°C (1200°F) and above 371°C (700°F). LRSI is of the same material construction as HRSI except that the tiles are 20 by 20 centimeters (8 by 8 inches) square and contain a white moisture-resistant coating with a surface emittance of 0.8 and a solar absorptance of 0.32. LRSI tiles range in thickness from 0.5 to 3.5 centimeters (0.2 to 1.4 inches). Approximately 7000 LRSI tiles are used on the orbiter vehicle.

Coated Nomex felt reusable surface insulation (FRSI) is used in areas where temperatures are lower than 371°C (700°F) during entry and 398°C (750°F) during ascent. FRSI, which is constructed of basic Nomex (Aramid) fiber, varies in thickness from 0.4 to 1.0 centimeter (0.16 to 0.4 inch) and is applied in 0.9- by 1.2-meter (3- by 4-foot) sheets that are coated with a silicone elastomer, providing an emittance of 0.8 and a solar absorptance of 0.32. FRSI covers approximately 50 percent of the orbiter's upper surface.

REINFORCED CARBON-CARBON

RCC for use on the orbiter NC and WLE is currently manufactured by the Vought Corporation. Fabrication begins with a rayon cloth that is treated with graphite and impregnated with a phenolic resin. This impregnated cloth is layed up as a laminate of 19 to 38 plies and cured in an autoclave. After cure, the laminate is pyrolyzed at high temperature to convert the resin to carbon. The part is then impregnated with furfuryl alcohol in a vacuum chamber, cured, and again pyrolyzed to convert the furfuryl alcohol to carbon. To obtain an oxidation-resistant coating, the material is packed in a retort with a mixture of alumina, silicon, and silicon-carbide, and placed in a furnace with an argon atmosphere at a temperature of 1760°C (3200°F). A diffusion reaction occurs that converts the outer carbon-carbon layers to silicon-carbide with no thickness increase. Oxidation resistance is then enhanced by impregnating the coated RCC part with tetraethyl-orthosilicate (TEOS). Together, the silicon-carbide and TEOS protect the internal layers of carbon-carbon from oxidation during entry into the earth's atmosphere.

The advantages of RCC are its good high-temperature mechanical properties and high resistance to fatigue loading. The primary disadvantage of RCC is associated with loss of strength due to subsurface oxidation, which is greatest at intermediate operating temperatures around 870°C (1600°F).

The maximum size of individual RCC components is limited, from a practical sense, by the deflections of the structure and the linear growth that can be accommodated conveniently in the design as the material expands at high temperature. The WLE is made up of 44 RCC panels (22 for each wing) whereas the nose cap is one piece. The RCC panels are mechanically attached to the wing with a series of floating joints to reduce loading on the panels caused by wing deflections and differential thermal expansion. The seals between wing leading edge panels, referred to as "T-seals," are made of RCC. They allow lateral motion for thermal expansion between the RCC and wing structure, and prevent the direct flow of hot boundary-layer gases into the WLE cavity during entry.

Inconel 718, A-286, and titanium fittings are bolted to flanges on the RCC components and attached to the aluminum wing spars and nose bulkhead. Inconel-covered Dynaflex insulation protects the metallic attach fittings and spar from the heat emitted by the inside surface of the RCC wing panels. Inside the NC is a blanket made from ceramic fibers and filled with silica fibers and HRSI tiles to protect the forward fuselage from the heat emitted by the hot inside surface of the RCC.

In both the NC and WLE, internal heat is transferred primarily through radiation from the backside of the RCC components. Peak aerodynamic limit loading is on the order of 34.5 kilopascals (5 pounds per square inch) on the NC and 23.4 kilopascals (3.4 pounds per square inch) for the wing.

TEST PHILOSOPHY

Testing required to develop the RCC system can be categorized in three general areas: (1) materials characterization tests, (2) design evaluation tests, and (3) system design verification tests. Material characterization tests were conducted to develop basic thermal physical property data, optimize mechanical strength, and study degradation processes. Design evaluation tests were performed on full-scale RCC components to verify analytical strength predictions, thermal performance, and design methods. System design verification tests were performed to verify not only RCC components but all of the elements and components that compose the total NC and WLE edge portions of the vehicle. Material characterization and design evaluation tests were primarily the responsibility of the RCC manufacturer, Vought Corporation, which was under contract to Rockwell. Rockwell was responsible for defining the system design verification tests.

The LESS test objectives to support flight certification fall into four principal categories: (1) to validate analytical modeling techniques, (2) to verify the mission life of hardware elements, (3) to verify structural integrity, and (4) to demonstrate the ability of floating mechanical joints to allow for expansion and contraction of RCC components.

VERIFICATION TEST REQUIREMENTS

In fulfilling the design and development responsibilities for the Shuttle orbiter, Rockwell is responsible for defining the various environmental conditions to which the orbiter will be exposed during its mission cycle. The simulation parameters of interest for the verification of the NC and WLE include critical environments of ascent, earth orbit, and atmospheric entry. The various environmental conditions and their respective mission time lines were studied to determine the critical factors and their principal degrading effects. These studies indicated that three different environmental tests were required to simulate the most critical flight mission exposure: acoustic excitation, structural airloads, and thermal conditions of earth orbit and atmospheric entry. No single facility can produce all of the desired environmental conditions. However, it was considered technically justifiable and experimentally expedient to expose the system components to the three environments sequentially in different test facilities to accumulate valid damage effects.

Basically, the requirement was to apply the three environments in their order of occurrence during the mission—i.e., launch acoustics, orbit and entry temperatures, followed by landing airloads. Upon development of the detailed test plans, however, it was considered prudent to perform all airload tests before the orbit and entry thermal exposure to minimize instrumentation refurbishment requirements during the three environmental exposures. In addition to instrumentation considerations, it was desirable to certify the hardware systems incrementally on a flight-by-flight basis. This approach, in addition to its overall schedule advantages, was more conservative and able to accommodate anomalies that might develop during the test program. The final decision

was to expose each article incrementally to simulated acoustic, airload, and thermal environments in four test phases—Phase A being equivalent to 8 missions, B to 16, C to 24, and D to an additional 52 mission cycles (Table 1).

TEST ARTICLE DESCRIPTION

The NC and WLE certification test articles (Figures 3 and 4) were designed to encompass all structural, mechanical, and thermal boundaries essential to proper evaluation of the related RCC components. The NC article consisted of the complete RCC nose cap assembly: forward shell, T-seal, expansion seal, internal insulation blankets, and fuselage closeout system, plus a section of the forward fuselage structure, closeout HRSI tile, and acreage tile. The WLE test article consisted of two RCC panels (No. 16 and 17) of the right-hand wing and interconnecting T-seal, all RCC attach fittings, wing front spar thermal insulation, attach fitting insulation, and a section of wing structure.

The NC and WLE were the selected test article configurations because they comprise the fewest component parts yet represent all of the mechanical, structural, and thermal boundaries required to evaluate the system's performance. Additional simulated or RCC panels were required on both sides of RCC Panels 16 and 17 to provide realistic structural closeout during acoustic testing.

There are some differences between the test article configurations and the actual NC and WLE of the orbiter vehicle scheduled for the first orbital flight as a result of ongoing design changes that were judged to have minimal effect on the system evaluation and could be accounted for by analytical procedures. The NC test article has a modified RCC T-seal on the lower side whereas the current design is segmented with a designed aerodynamic overlapping joggle. The test strip was simply cut before coating to allow for the equivalent expansion freedom. Acreage tile was obtained from production rejects. The aft sections of the WLE upper and lower surfaces were also covered with rejected tiles for structural protection in the thermal test and for dynamic influence on the structure in the acoustic tests. The WLE test article was fabricated from a dedicated test article identified as WA-19, originally built for the acoustic fatigue test program. The NC test article was designed and fabricated uniquely for the RCC verification program and required only instrumentation changes for different environments. The thermal configuration of the WLE employed insulating closeout panels at each end of RCC Panels 16 and 17, plus additional insulation on the remaining portions of the front spar. The acoustic configuration, as noted earlier, used a fiberglass panel (No. 18) plus supplemental fiberglass closeouts at the ends of Panels 16 and 18. The airload test configuration was the least complex, not requiring any special structural closeouts at the ends of the RCC panels.

FACILITIES AND TESTING

Facility considerations and test methodology were based on meeting Shuttle acoustic, airload, and thermal requirements.

Acoustics

An acoustic facility capable of meeting the NC and WLE test requirements was nonexistent at the inception of the Shuttle program. However, the vibration and acoustic test facility (VATF) at NASA's Johnson Space Center (JSC), originally constructed to support the Apollo program, was upgraded early in the Shuttle program to develop the high acoustic levels needed to simulate the orbiter's flight regime. For the acoustic tests, the NC and WLE articles were placed in acoustic reverberation rooms. The setup for the NC test is shown in Figure 5. The acoustic test levels and spectra are shown in Figures 6 and 7.

Before the NC and WLE were acoustically excited, structural modal tests were performed. A small shaker was used to excite the structure dynamically while accelerometers mounted at preselected locations on the outer surface of the RCC were monitored. Results of the modal tests were used to determine areas most responsive to acoustic excitation so that instrumentation locations could be optimized. Appropriate acoustic closeouts were provided to prevent direct test-level sound impingement upon internal areas of the test article. The average of ten surface-mounted microphones was used to establish the acoustic test environments. Additional microphones were used to measure the sound field at locations inside the test articles.

The test article responses were sensed by accelerometers and strain gages. The reverberant rooms were large enough—12.2 by 5.8 by 4.9 meters and 14.3 by 11.6 by 9.8 meters (40 by 19 by 16 feet and 47 by 38 by 32 feet)—to provide many resonance frequencies and good sound-field quality in all one-third octave bands at and above 50 hertz. In addition to the reverberant environment, a 100-hertz "hot-spot" horn was placed 10 centimeters (4 inches) from the surface of the NC to generate an 88- to 112-hertz sine-sweep acoustic field simultaneously with the application of the aerodynamic field.

Airloads

Special simulated airload structural test systems were required to meet the RCC test objectives. Limited airload simulation as well as acoustic and thermal testing techniques had been developed at the Vought Corporation during early RCC shell development tests. Even though the specific Vought testing techniques were not used for the NC and WLE system test programs, the Vought experience served as the basis for many of the final systems and facilities that were developed for the system test program.

The airloads tests were conducted in the JSC structures test laboratory (STL). The test setups and loading systems (Figure 8) were designed especially to fit the specific size and test requirements of the NC and WLE articles. The basic structural test system design approach was to surround each article completely with a self-contained reaction loading fixture. Each fixture contained hydraulic load application jacks, strategically located to apply loads normal to the test surface. Because of the varying pressure distribution, 54 load pads and 39 load jacks were required on the NC test article; 61 load pads and 22 load jacks were required on the WLE test article. Metal pads applied loads uniformly through 2.5-centimeter (1-inch) foam pads, as shown in Figures 9 and 10.

The test conditions for the NC were relatively simple: all loads were compressive with the design limit and fatigue load levels of the same sign and magnitude (Figure 11). The design limit loading for the WLE, however, included both compression and tension loads, and required different and complex loading for the fatigue test series. The WLE fatigue load spectrum consisted of three different up loads and three different down loads, all of varying sign and magnitude, as shown in Figure 12.

Initially, the NC appeared to have a buckling instability condition, which resulted in a special requirement to design an NC load application system that allowed buckling freedom. The system design used 54 compartment air bags that corresponded to the load pad geometry and separate free-standing support frames to isolate movement of the deflection transducers from that of the reaction frame.

The hydraulic load application system presented another special and unique design issue. Although the requirements could have been met through the use of a servocontrolled load system, the relatively large quantity of load channels rendered such a system cost and schedule prohibitive. From several conventional hydraulic load maintainers available from earlier test programs, a system of automatic valves and timers was used to design and fabricate the desired test mechanism. Mechanical load limiters were combined with an automatic load abort capability from the computerized data acquisition systems to provide test article safety from inadvertent overload or underload conditions.

Temperature

During the thermal tests, the NC and WLE articles had to be subjected simultaneously to the local temperature distributions and the temperatures and pressures to be experienced by the orbiter during atmospheric entry to simulate the thermally induced TPS and structural deflections and stresses, as well as the degradation of RCC components due to subsurface oxidation.

The facility requirements to fulfill these objectives included (1) multichannel radiant heating systems capable of accommodating the NC and WLE test article geometries, providing the required temperature distributions and histories, and operating in an oxidizing atmosphere (e.g., air), (2) cooling systems for cold-soaking the test articles to on-orbit temperatures before initiation of the entry heating, (3) systems to alternate the test articles between the radiant heaters and cooling shrouds, (4) a vacuum chamber large enough to accommodate the test articles, radiant heaters, cooling shrouds, and translation hardware, (5) a vacuum pumping system of sufficient capacity to provide altitude simulation, and (6) a computer system for data acquisition, real-time data display, annunciation, abort of out-of-limit test or control parameters, and feedback control of individual heater zones to achieve prescribed temperature profiles by monitoring local test article surface temperatures.

Because no NASA or industrial facility could meet all of these requirements, a capability was established at NASA JSC where the other sequential environmental simulation tests (acoustic and airloads) were to be conducted on the NC and WLE to minimize problems associated with test article logistics, handling damage, inspections, and instrumentation refurbishment.

The thermal facility (Figure 13), known as the JSC 5-megawatt radiant heating test facility (RHTF), consists of a vacuum chamber 3.3 meters (10 feet) in diameter and 6 meters (20 feet) long; a vacuum pumping system that can simulate altitude pressure within ± 1 torr over a range of 0.07 to 760 torr; cryogenic shrouds cooled with liquid nitrogen, glycol, or methanol refrigerants that can cool the test articles to a temperature of -129°C (-200°F); test article translation and rotation systems; a 256-channel data acquisition and feedback control system with annunciation and abort limit checking of all channels; and modular heater systems tailored to the NC and WLE test articles.

The radiant heater systems developed for the NC and WLE thermal certification tests are unique. The NC heater (Figure 14) consists of 96 triangular and trapezoidal graphite elements configured to the NC geometry and grouped into 22 individual control zones to simulate the temperature distributions to be experienced by the NC during entry. The WLE heater (Figure 15) consists of nine heater modules, each containing four 1.8-meter (72-inch) graphite elements. The modules are configured to the WLE geometry and are individually controlled to simulate the temperature distributions experienced on the WLE during entry. The heater and overall test system are shown in Figures 15 and 16.

The initial tests (Phase A) required to certify the orbiter for its first flight will use uncoated graphite heater elements in an inert (nitrogen) atmosphere. Subsequent tests (Phases B, C, and D) will use silicon-carbide-coated graphite heater elements, developed to operate in an oxidizing (air) atmosphere. A silicon-carbide coating is required on the heater elements for the same reason it is used on the RCC—to inhibit oxidation and prolong element life. In addition, silicon-carbide elements must be used with a prescribed air bleed rate to ensure that the partial pressure of oxygen is representative of flight. If the mission-life certification tests (Phases B, C, and D) were conducted with uncoated heater elements, the test objectives could not be attained because the altitude control system's vacuum unit can handle only limited air flows and the available oxygen would react much more readily with the bare elements than with the test articles, resulting in an inadequate simulation of RCC subsurface oxidation.

Because of the poor reliability of thermocouples at the peak temperatures required for these tests, fiber-optic infrared pyrometers were purchased for noncontact monitoring of test article surface temperatures and providing a signal for feedback computer control of each heater control zone. The fiber-optic lens system views the test article surface through a hole in the heater reflector and between heater elements.

RESULTS AND DISCUSSION

Phase A WLE acoustic fatigue testing was completed in May 1978 as part of the acoustic fatigue test program, which used the WA-19 WLE test article configuration. The WLE WA-19 test article was then returned to Rockwell for refurbishment and upgrading to the latest design configuration; it was returned to JSC in December 1979. The Phase A WLE airload tests were completed in March 1980, whereupon the test article was disassembled, inspected, and equipped with thermal instrumentation in preparation for the Phase A thermal tests scheduled for July and August 1980.

The NC test article was delivered to the JSC vibration and acoustic test facility, where Phase A acoustic tests were completed in January 1979. The Phase A NC airload tests were completed in February 1980. However, inspection, disassembly, and refurbishment in preparation for the Phase A thermal tests revealed that the internal high-temperature insulation blankets required redesign and replacement. This necessitates repeating the acoustic exposure before the thermal tests are conducted. The retest of the Phase A NC acoustic test is scheduled for June 1980, and the Phase A NC thermal tests are planned for August and September 1980.

Completion of the Phase A NC and WLE testing, presently scheduled for September 1980, will support certification of the orbiter LESS for the first orbital flight. The Phase B, C, and D testing will then continue until the NC and WLE test articles undergo 100 mission exposures to each environment—sometime in February 1982.

CONCLUDING REMARKS

A unique multienvironment, incremental test program was developed and implemented through the combined efforts of Rockwell and NASA JSC to support certification of the orbiter LESS for a 100-mission life. Three facilities at JSC (VATF, STL, and RHTF) were used to expose full-scale NC and WLE test articles sequentially to acoustic excitation, structural airloads, and on-orbit cold soak and entry temperatures to simulate critical flight environments.

TABLE I. TEST SEQUENCE

Test Phase	Sequence	Tests	Test Duration Equivalent Missions	Supports Certification for Flights
A	1	Acoustics	32	1 - 2
A	2	Airloads (design limit) (fatigue spectrum)	1 32	1 - 2
A	3	Thermal (nonoxidizing)	8	
B	4	Thermal (oxidizing)	16	
B	5	Airloads (fatigue spectrum)	64	3 - 6
B	6	Acoustics	64	
C	7	Thermal (oxidizing)	24	
C	8	Airloads (fatigue spectrum)	96	7 - 12
C	9	Acoustics	96	
D	10	Thermal (oxidizing)	52	
D	11	Airloads (fatigue spectrum)	208	13 - 100
D	12	Acoustics	208	
D	13	Airloads (ultimate loads)	1	

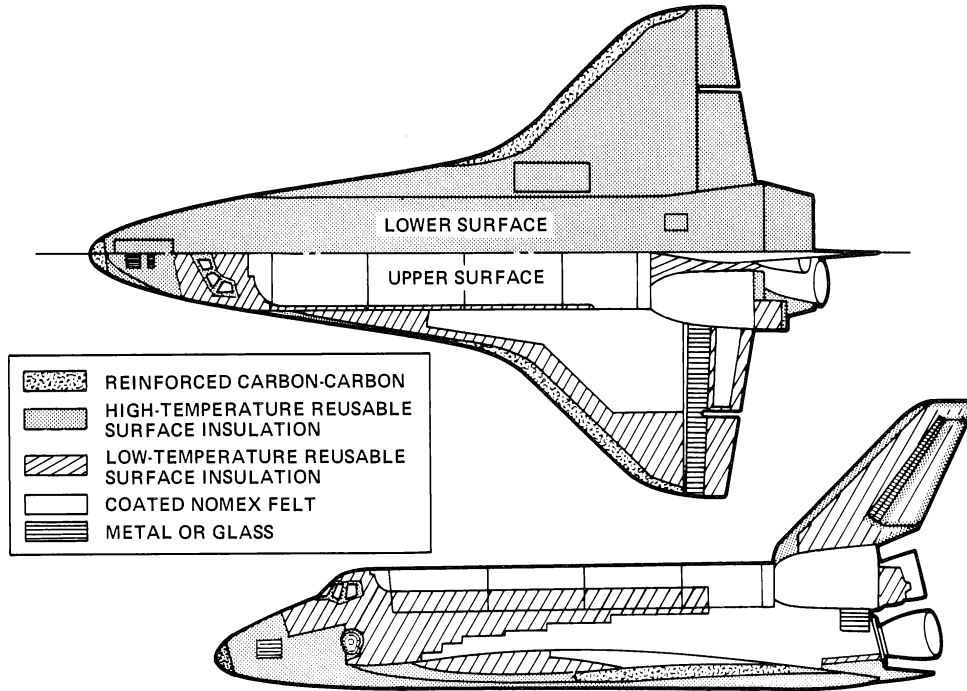

Figure 1. Orbiter Thermal Protection System

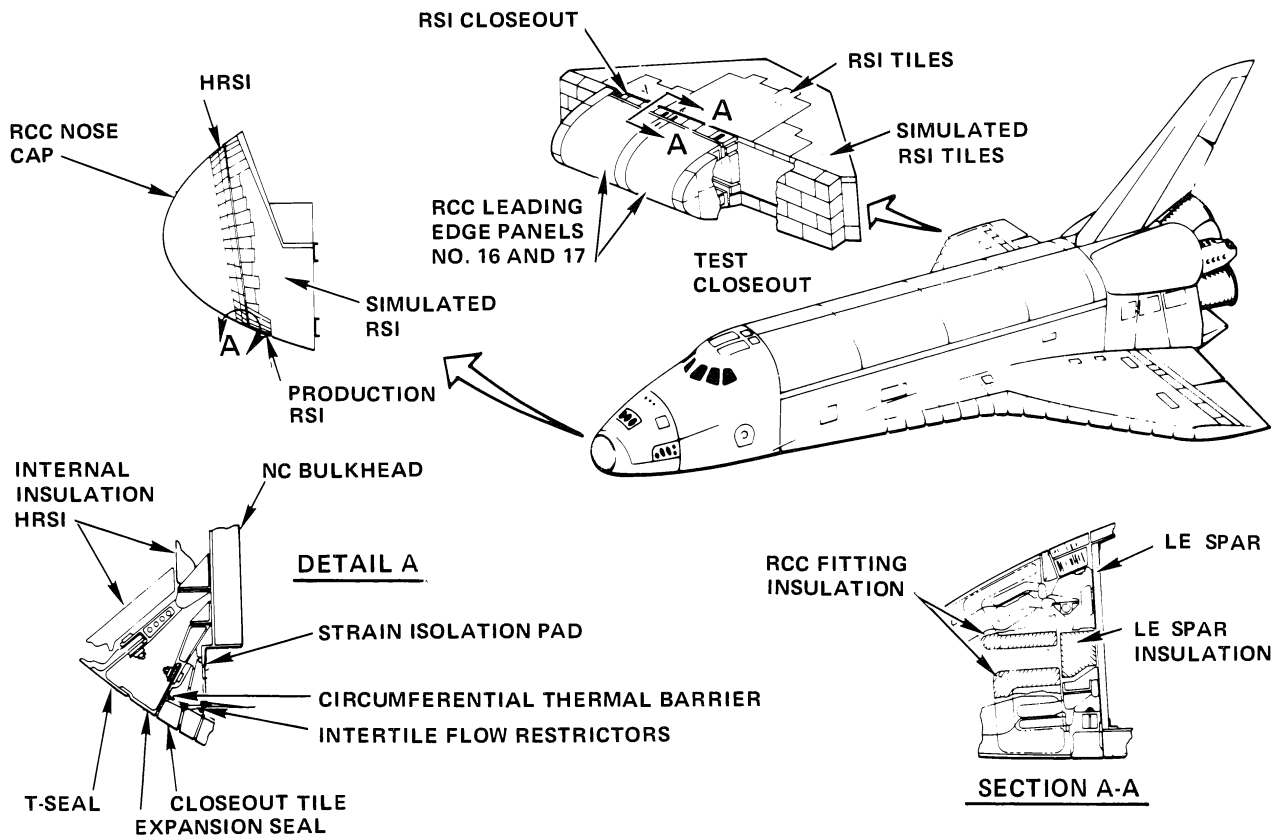

Figure 2. Nose Cap and Wing Leading Edge Test Articles

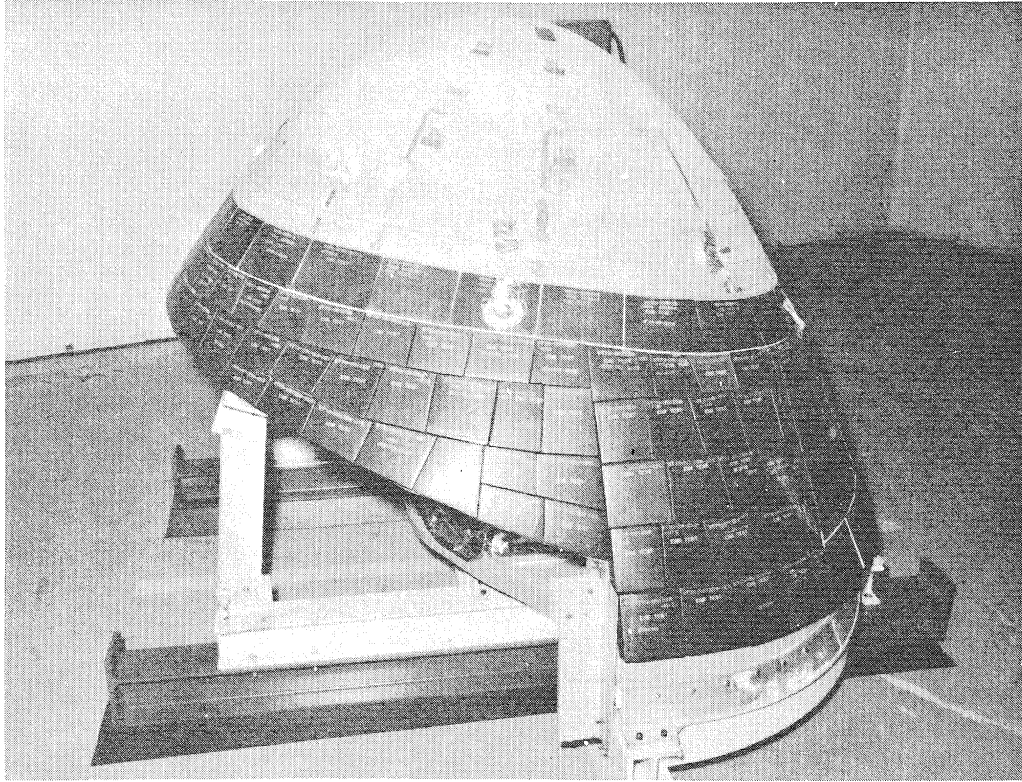

Figure 3. Nose Cap Test Article

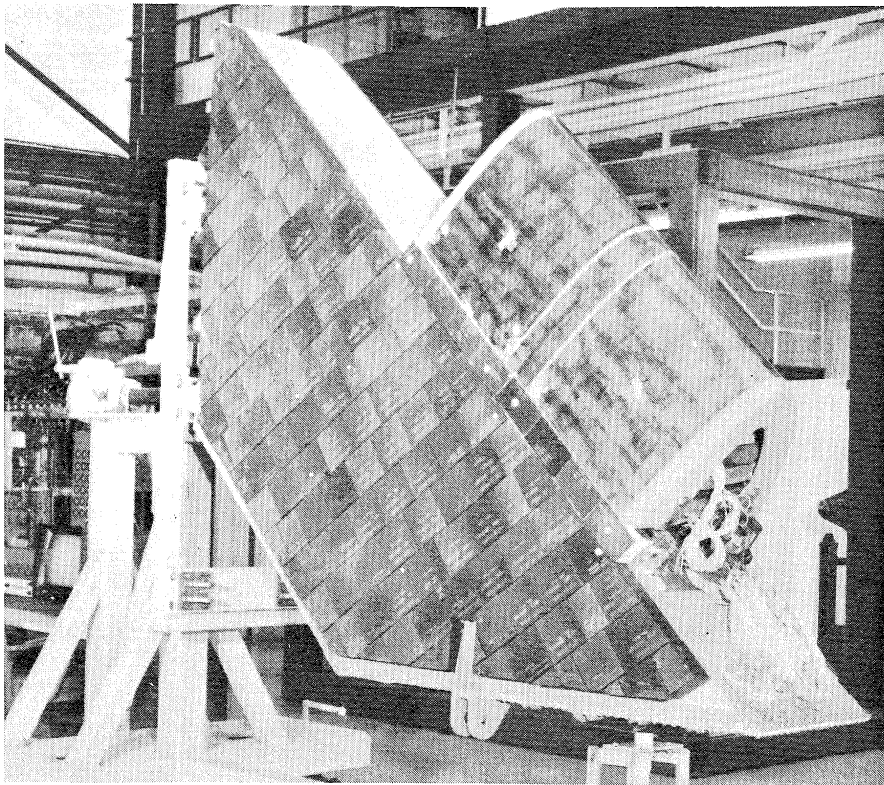

Figure 4. Wing Leading Edge Test Article

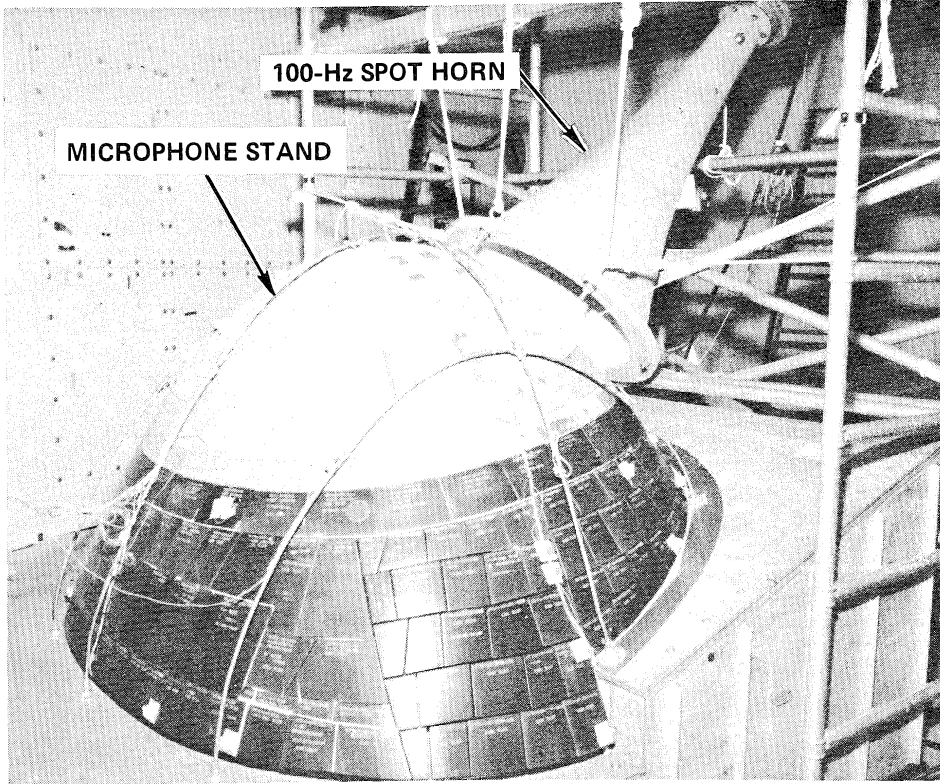

Figure 5. Nose Cap Acoustic Test Setup

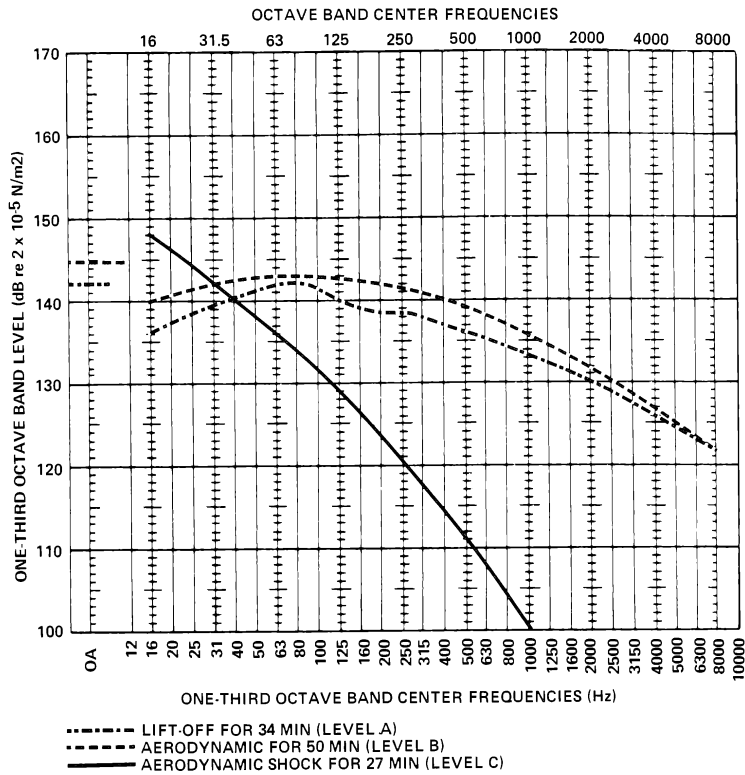

Figure 6. Acoustic Test Environment for Nose Cap

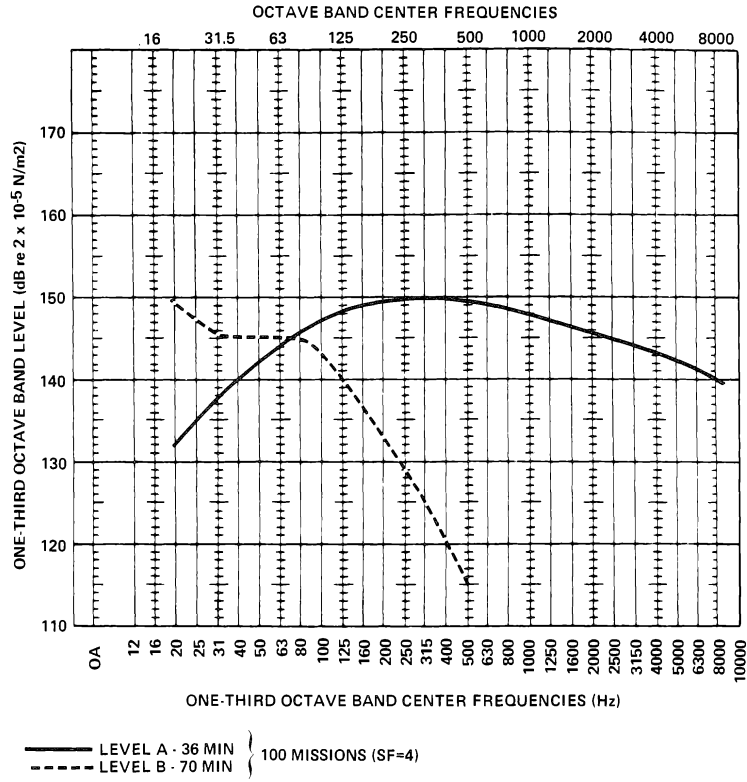

Figure 7. Acoustic Test Environment for Wing Leading Edge

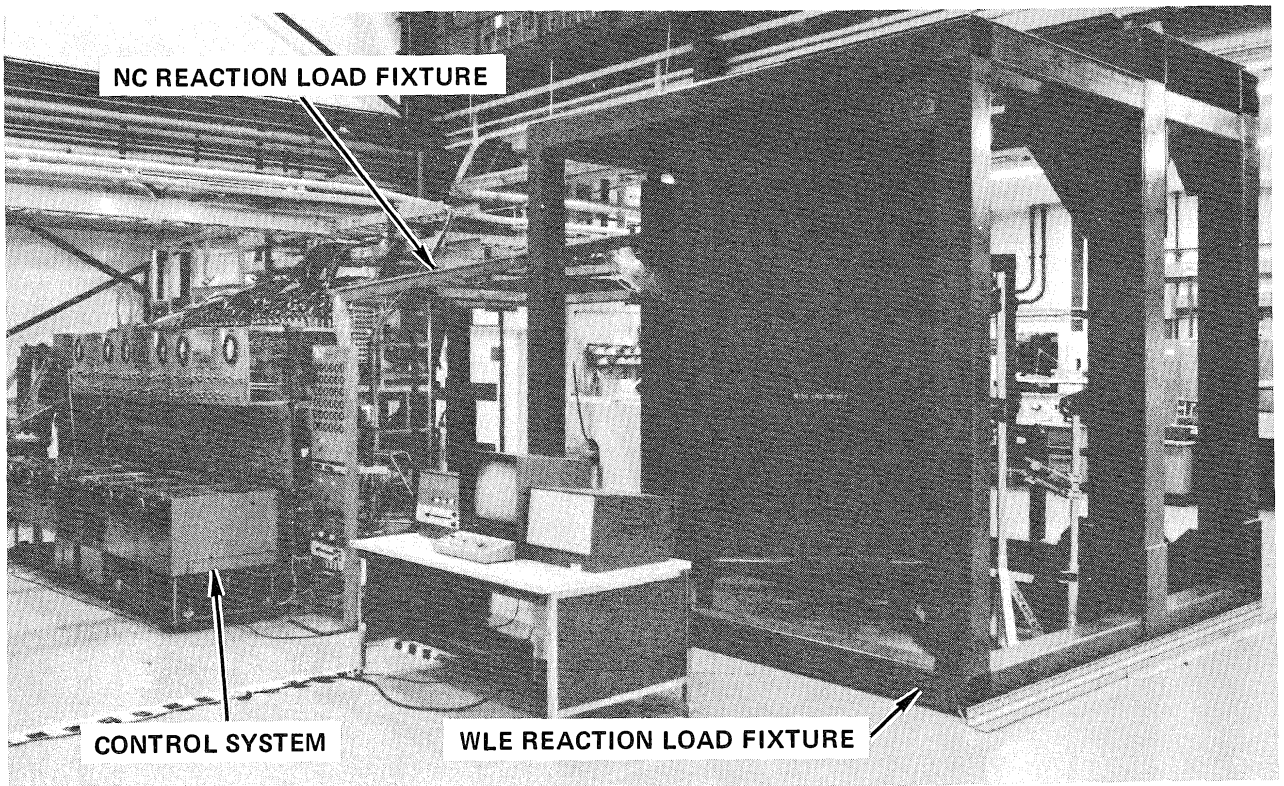

Figure 8. Airloads Test Setup

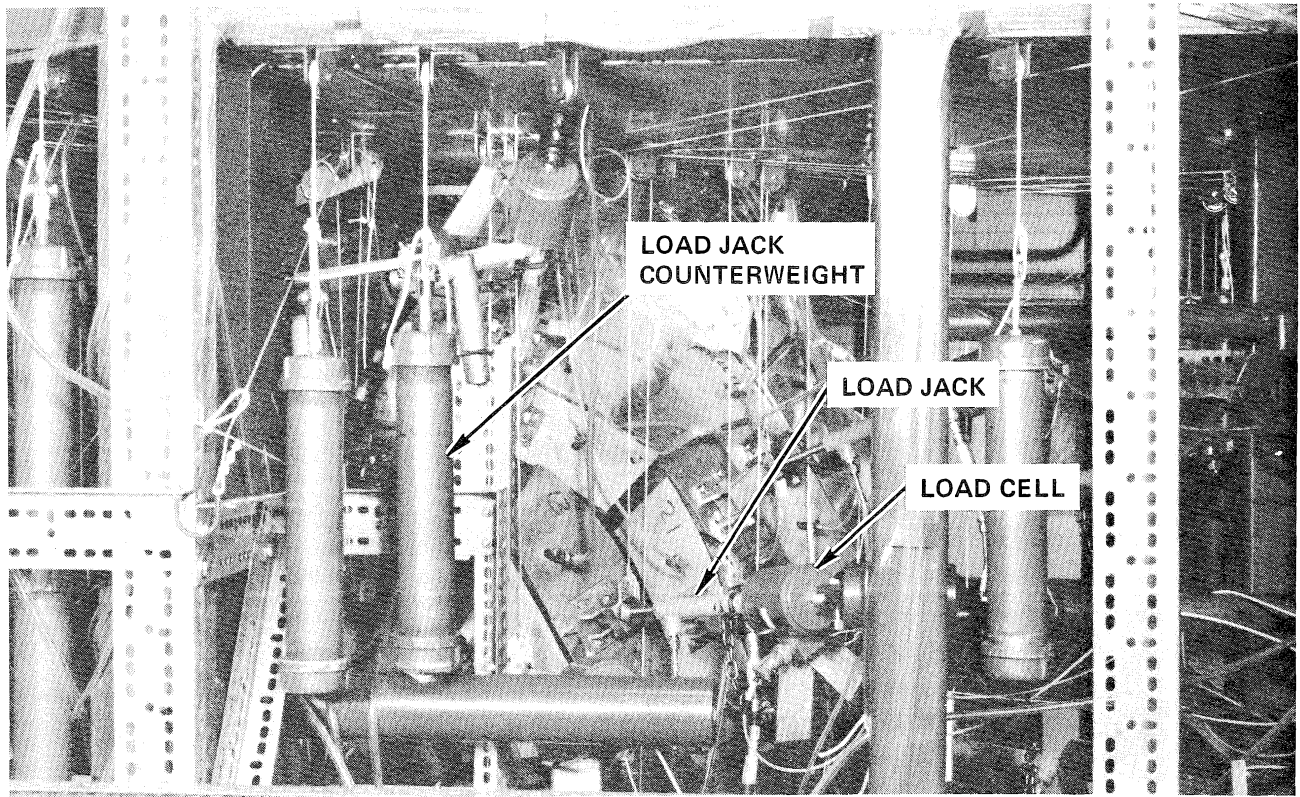

Figure 9. Nose Cap Airloads Test Setup

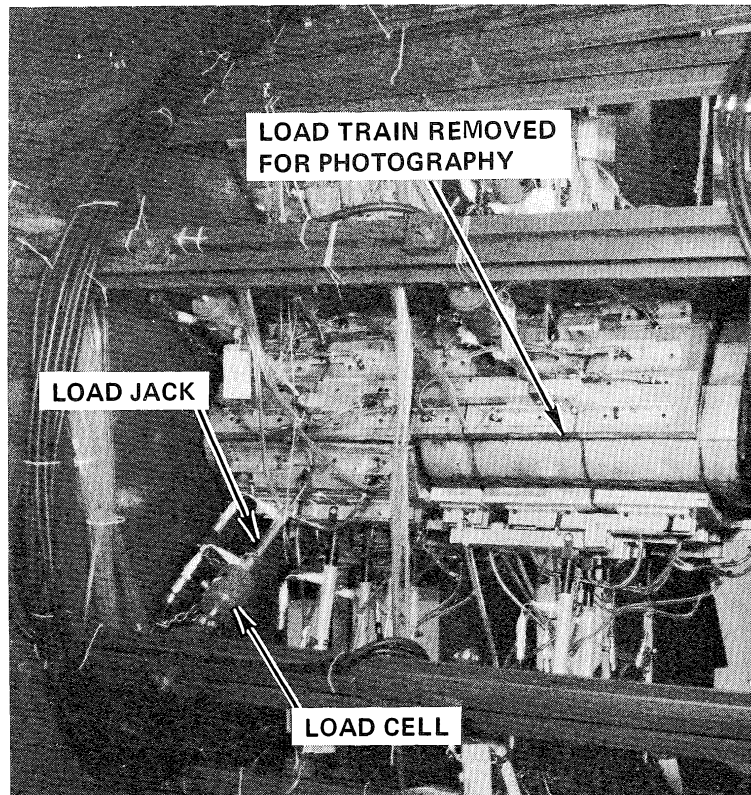

Figure 10. Wing Leading Edge Airloads Test Setup

BODY STATION (IN.)	PRESSURE (PSIA)					
	$\phi = 0^\circ$	$\phi = 20^\circ$	$\phi = 40^\circ$	$\phi = 55^\circ$	$\phi = 70^\circ$	$\phi = 90^\circ$
236.00	11.190	11.190	11.190	11.190	11.190	11.190
236.65	11.045	11.032	11.019	11.008	10.999	10.985
246.32	8.898	8.688	8.477	8.307	8.158	7.947
265.67	6.035	6.177	6.787	7.074	7.183	7.274

	$\phi = 105^\circ$	$\phi = 120^\circ$	$\phi = 135^\circ$	$\phi = 150^\circ$	$\phi = 165^\circ$	$\phi = 180^\circ$
236.00	11.190	11.190	11.190	11.190	11.190	11.190
236.65	11.020	11.054	11.098	11.122	11.156	11.190
246.32	7.990	8.032	8.075	8.118	8.160	8.203
265.67	7.327	7.358	7.333	7.283	7.208	7.132

- LOADS ARE SYMMETRICAL ABOUT VERTICAL AXIS.
- INTERMEDIATE VALUES DETERMINED BY LINEAR INTERPOLATION RELATIVE TO BODY STATION AND ϕ .

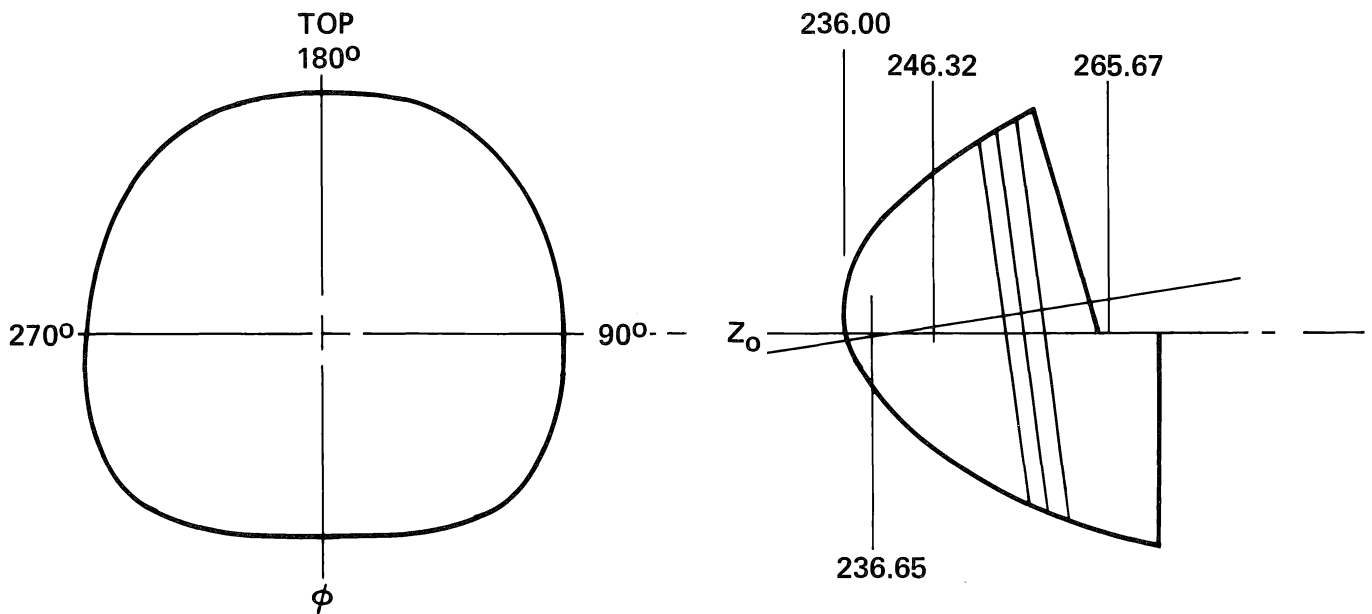

Figure 11. Nose Cap Design Limit Loads

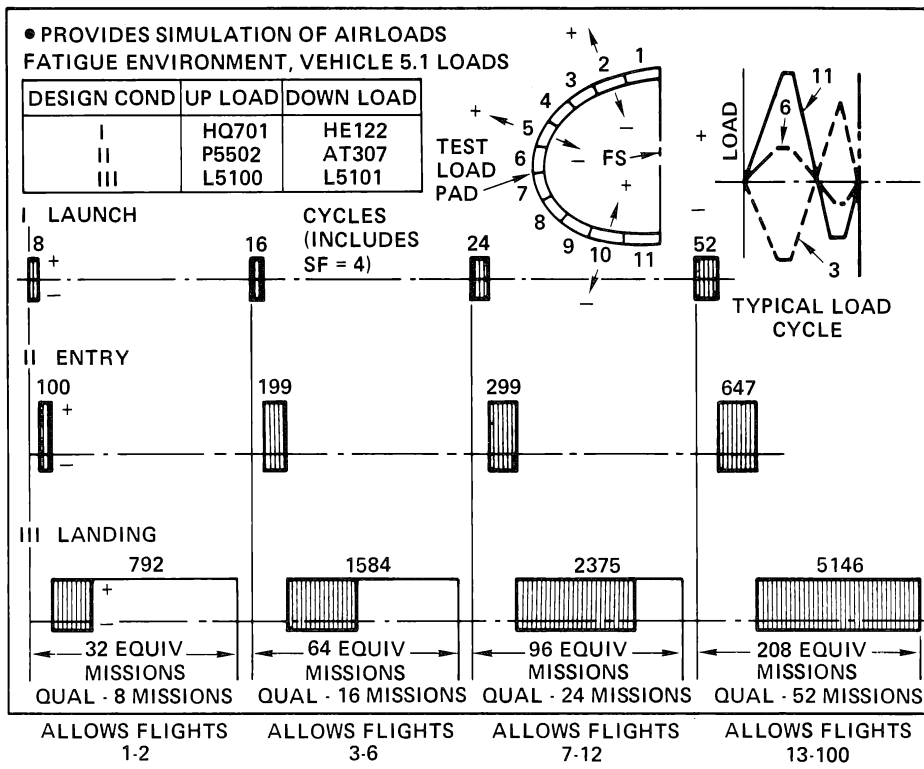

Figure 12. Wing Leading Edge Airloads Spectrum

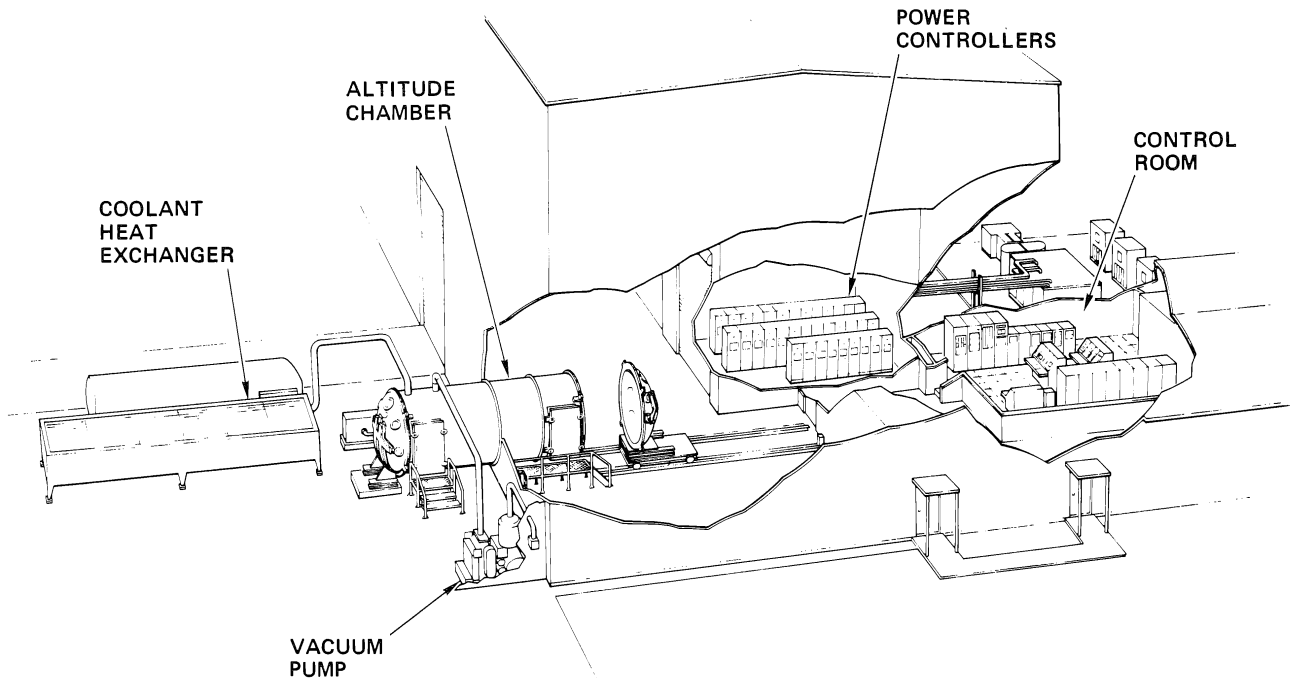

Figure 13. Radiant Heating Test Facility

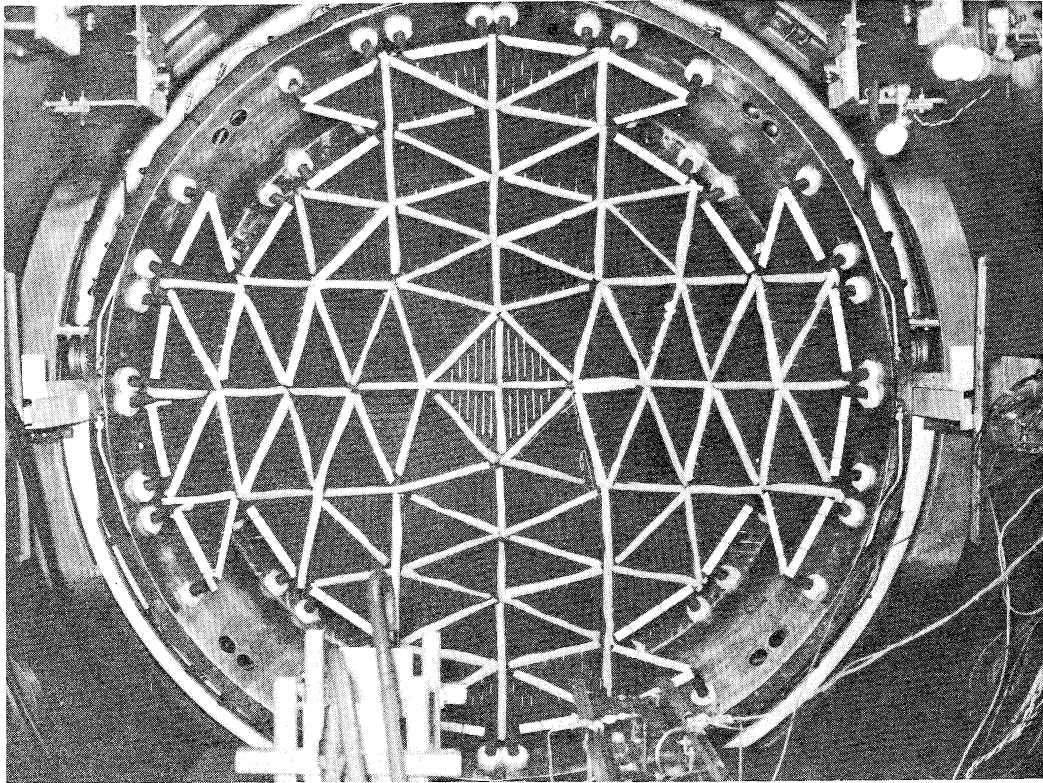

Figure 14. Nose Cap Heater

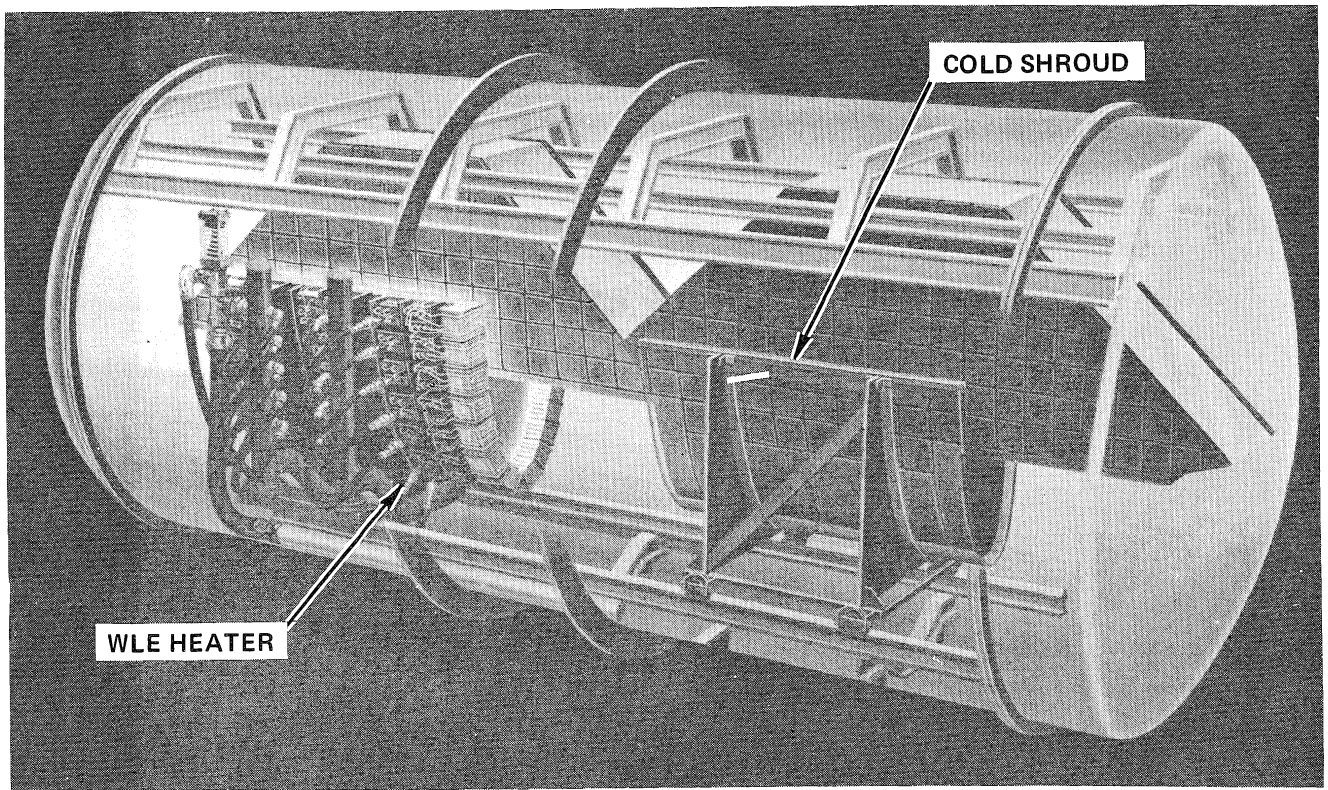

Figure 15. Artist's Concept of Wing Leading Edge Test System (Test Article Shown in Both the High- and Low-Temperature Positions)

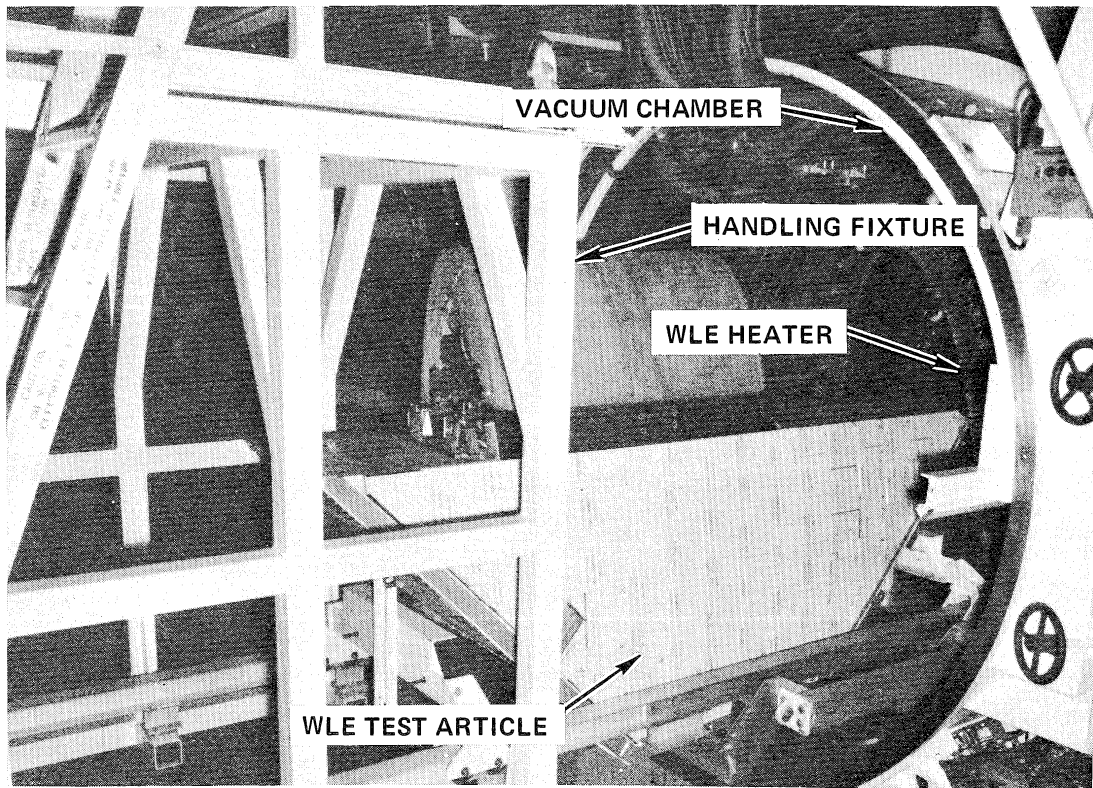

Figure 16. Wing Leading Edge Test Setup